

Open an on-line trade account TODAY!

- ✓ Over 20 years of technical CCTV knowledge
- ✓ 97% of products held in stock
- ✓ Order before 4pm, for Next Business Day delivery
- ✓ Expert technical sales advice
- ✓ Price match promise on all 'like for like' quotations
- ✓ Free technical support
- ✓ 48 hour repairs - the best in the industry
- ✓ 2 year warranty on all products

**5MP IP
Coming
Soon**

TRADE CATALOGUE 2016



CCTV Cameras DVR's and Accessories



DESIGNED & PRODUCED BY WWW.MARKETINGCALCHEMY.CO.UK 0800 2707680



Digital Direct Security

Unit 7 Osprey Court,
Hinchbrooke Business Park,
Huntingdon,
Cambridgeshire PE29 6FN

 Follow us on Twitter @DDSCCTV

Subject to DDS standard conditions of sale. All prices are subject to delivery and VAT. Specifications and prices are subject to change without notice, E. & O. E. All trademarks acknowledged.

The DDS Difference

- ✓ 2 YEAR Warranty as standard
- ✓ FREE Technical Support
- ✓ FREE Config Help & Training
- ✓ IN STOCK for Next Day Delivery
- ✓ FAST 48 Hour Repair Service

HUGE RANGE... HIGH QUALITY... LOW PRICES

 www.ddstrade.co.uk  **01480 459809**

HUGE RANGE... HIGH QUALITY... LOW PRICES

 www.ddstrade.co.uk  **01480 459809**

HD Resolution Explained

A 'Full D1' Analogue camera has a resolution of 720(H) x 576(W). Multiply together to get the number of pixels (in this case = 0.415MP). Full HD resolution is 1920(H) x 1080(W) multiplied together = 2.1MP, i.e. 2.1MP/0.415MP = 5.06 (5 times more pixels, 5X better resolution).

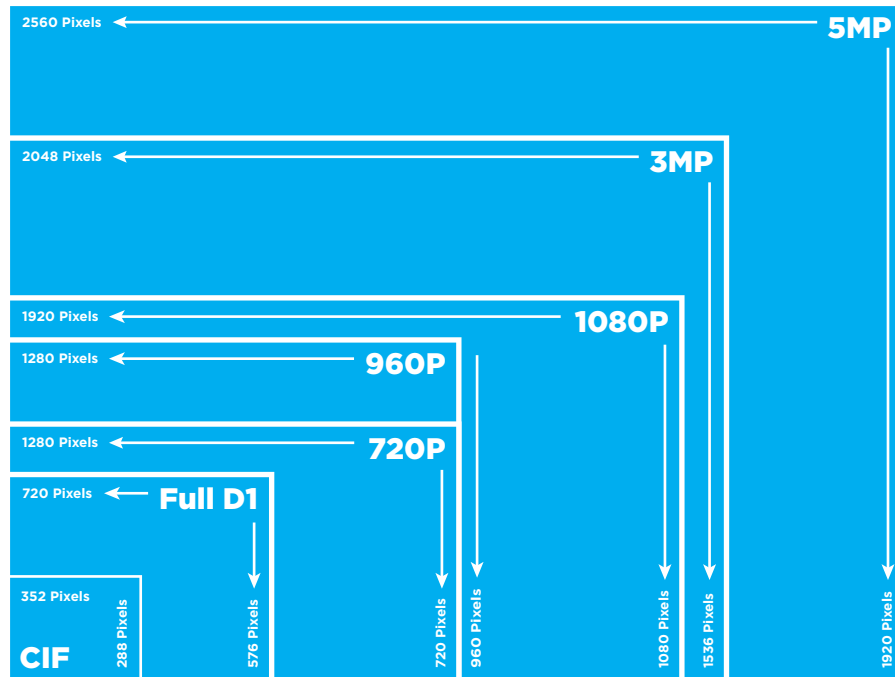

Camera Chipsets

Not all cameras are the same. Chipset combination (imaging sensor and DSP) can have a huge impact on quality.

See the opposite example.



AHD

- ▶ AHD 720P Cameras
- ▶ AHD 1080P Cameras
- ▶ AHD PTZ Cameras
- ▶ AHD Accessories

04

HD-TVI

- ▶ HD-TVI 1080P Cameras
- ▶ HD-TVI PTZ Cameras
- ▶ HD-TVI Accessories

08

HD-SDI

- ▶ HD-SDI Cameras
- ▶ HD-SDI PTZ Cameras
- ▶ HD-SDI Accessories

12

DVR

- ▶ Guardian AHD DVR
- ▶ MicroLite AHD DVR
- ▶ Phoenix TVI/AHD DVR
- ▶ Scorpion HD-SDI DVR
- ▶ MicroLite-HD DVR

16

IP

- ▶ IP 1080P Cameras
- ▶ IP PTZ Cameras
- ▶ IP Avenger NVR
- ▶ POE Switches
- ▶ IP Accessories

26

CCTV KITS

- ▶ AHD Camera/DVR Kits
- ▶ TVI Camera/DVR Kits
- ▶ HD-SDI Camera/DVR Kits
- ▶ IP Camera/NVR Kits

32

PSU/Cables

- ▶ Power Adapters
- ▶ Power Supplies
- ▶ RG59 and Cat5 Cable

36

Accessories

- ▶ Monitors
- ▶ Junction Boxes
- ▶ Cable Connectors
- ▶ Keyboards and Brackets
- ▶ DVR Enclosures
- ▶ IR Lamps

38

AHD 720P Features

- ✓ SONY 1.3MP CMOS Sensor (1/3")
- ✓ AHD 720P/960P Resolution
- ✓ IR-CUT Filter
- ✓ DWDR, 3D-DNR, BLC
- ✓ IP66 Rating

Compatible DVRs

- ▶ Guardian Range
- ▶ MicroLite Range
- ▶ Phoenix Range

**P16-17
P18-19
P20-21**



AHD-419R

- ✓ Fixed-Focal 3.6mm Lens
- ✓ Day/Night (30 IR LEDs, IR Range 20m)
- ✓ Low Light 0 Lux F1.2



AHD-579VR

- ✓ Vari-Focal 2.8-12mm (adjustable) 2MP Lens
- ✓ Day/Night (42 IR LEDs, IR Range 30m)
- ✓ Low Light 0 Lux F1.2
- ✓ Optional B230 Base



AHD-659R

- ✓ Fixed-Focal 3.6mm Lens
- ✓ Day/Night (24 IR LEDs, IR Range 10-15m)
- ✓ Low Light 0 Lux F1.2
- ✓ Eyeball (position in any direction)



AHD-779VR

- ✓ Vari-Focal 2.8-12mm (adjustable) 2MP Lens
- ✓ Day/Night (36 IR LEDs, IR Range 20-25m)
- ✓ Eyeball (position in any direction)
- ✓ Optional B170 Base



AHD-049SD

- ✓ Fixed-Focal 3.6mm Lens
- ✓ Low Light 0.1 Lux F1.2
- ✓ For Internal Use Only



AHD1080-779VR

- ✓ Vari-Focal 2.8-12mm (adjustable) 2MP Lens
- ✓ Day/Night (36 IR LEDs, IR Range 20-25m)
- ✓ Low Light 0 Lux F1.2
- ✓ Eyeball (position in any direction)
- ✓ Optional B170 Base



AHD1080-579VR

- ✓ Vari-Focal 2.8-12mm (adjustable) 2MP Lens
- ✓ Day/Night (42 IR LEDs, IR Range 30m)
- ✓ Low Light 0 Lux F1.2
- ✓ Optional B230 Base



AHD 1080P Features

- ✓ SONY 2.4MP CMOS (1/2.8") Sensor
- ✓ AHD 1080P Resolution
- ✓ IR-CUT Filter
- ✓ IP66 Rating
- ✓ DWDR, 3D-DNR, BLC

Compatible DVRs

- ▶ Phoenix EN Series

P20-21



The DDS Difference

- ✓ 2 YEAR Warranty as standard
- ✓ FREE Config Help & Training
- ✓ FREE Technical Support
- ✓ IN STOCK for Next Day Delivery
- ✓ FAST 48 Hour Repair Service

AHD PTZ Features

- ✓ SONY CMOS Sensor
- ✓ AHD 720P or 1080P Resolution
- ✓ Auto/Manual Focus Iris
- ✓ IP66 Rating
- ✓ 3D-DNR
- ✓ RS485, Pelco P/D

Compatible DVRs

- ▶ Phoenix EN Series

P20-21



AHD-SD85-10IR

- ✓ 1.4MP SONY CMOS Sensor (1/2.8")
- ✓ AHD 720P/960P Resolution
- ✓ Day/Night (6 Hi Power LEDs, IR Range 50m), ICR
- ✓ 10X Optical Zoom, Digital Zoom
- ✓ Vari-Focal 5.1-51mm (adjustable) Lens
- ✓ Supports Presets and Tours
- ✓ Includes 12v DC Power Supply Unit
- ✓ Wall Mounting
- ✓ Optional Corner/Pole Mount



AHD1080-SD85-10IR

- ✓ 2MP SONY CMOS Sensor (1/2.8")
- ✓ AHD 1080P/AHD720P Resolution
- ✓ Day/Night (6 Hi Power LEDs, IR Range 50m), ICR
- ✓ 10X Optical Zoom, Digital Zoom
- ✓ Vari-Focal 5.1-51mm (adjustable) Lens
- ✓ Supports Presets and Tours
- ✓ Includes 12v DC Power Supply Unit
- ✓ Wall Mounting
- ✓ Optional Corner/Pole Mount



AHD1080-SD86-20IR

- ✓ 2MP SONY CMOS Sensor (1/2.8")
- ✓ AHD 1080P/AHD720P Resolution
- ✓ Day/Night (IR Range 80m)
- ✓ 20x Optical Zoom, 12x Digital Zoom
- ✓ Vari-Focal 4.7-94mm (adjustable) Lens
- ✓ SSNR Noise Reduction
- ✓ Wide Dynamic Range (WDR)
- ✓ Supports Presets, Tours, Auto Scan, Privacy Zones, Alarms
- ✓ Includes 24v Power Supply Unit
- ✓ Wall Mounting
- ✓ Optional Corner/Pole Mount



UTP-112PHD

- ✓ Transmits Video and Power Over 1 CAT5 Cable
- ✓ Transmission Distance: AHD 720P up to 300m, AHD 1080P up to 150m, Analogue up to 500m
- ✓ Power Transmission to 50m
- ✓ BNC Male to RJ45 Connector With 13cm Mini Coax Cable for Easy Connection
- ✓ Passive Transceiver
- ✓ Supplied as a Pair



UTP-112HD

- ✓ Transmits Video Over 1 CAT5 Cable
- ✓ Transmission Distance: AHD 720P up to 300m, AHD 1080P up to 150m
- ✓ BNC Male to Screw Terminal With 10cm Mini Coax Cable for Easy Connection
- ✓ Passive Transceiver - No Power Required
- ✓ Supplied as a Pair



TTP-111HDP-LK

- ✓ Transmits Video Over 1 CAT5 Cable
- ✓ Transmission Distance: AHD 720P up to 300m, AHD 1080P up to 200m (Max)
- ✓ Power Transmission to 50m
- ✓ Built in ESD, EFT (impulse noise) and Transient Protection
- ✓ Passive Transceiver
- ✓ Supplied as a Pair



TTP-414HD

- ✓ Transmits up to 4 Video Signals (4 BNC to 1 RJ45)
- ✓ Includes 8 Pin Terminal Block
- ✓ Transmission Distance: AHD 720p up to 300m, AHD 1080P up to 200m (Max)
- ✓ Passive Transceiver - No Power Required
- ✓ One Required at Each End of Cable



AD001AHD-U

- ✓ Converts AHD 720P/1080P Signal to HDMI, VGA or as Analogue Composite Video
- ✓ Supports AHD Loop Feature
- ✓ For Use With AHD 720P/1080P Cameras
- ✓ Output Support: HDMI, VGA, Composite Video
- ✓ Up to 3 Outputs, Simultaneously
- ✓ HDMI/VGA Output Support: 720p, 1080p
- ✓ Ideal to Support Local Spot Monitors by Camera
- ✓ Includes 12v Power Adapter

CD102HD-U

- ✓ Distributes HD-AHD Video
- ✓ Supports 720P/1080P Resolution
- ✓ 1 Input, 2 Outputs
- ✓ Built in EQ for Signal Reliability, With Amplifier
- ✓ Includes 12v DC Power Adapter



SP009

- ✓ Provides Protection for HD-TVI and AHD Devices
- ✓ Complies With IEC 61000-4-5
- ✓ BNC Male to BNC Female
- ✓ Built in EFT (impulse noise), Lightning Protection



HD-TVI 1080P Features

- ✓ SONY 2.4MP CMOS Sensor (1/2.8")
- ✓ TVI 1080P Resolution
- ✓ IR-CUT Filter
- ✓ WDR, DNR, BLC
- ✓ IP66 Rating

Compatible DVRs

▶ Phoenix J & EN Series

P20-21



TVI1080-419R

- ✓ Fixed-Focal 3.6mm Lens
- ✓ Day/Night (30 IR LEDs, IR Range 20m)
- ✓ Low Light 0 Lux F1.2



TVI1080-579VR

- ✓ Vari-Focal 2.8-12mm (adjustable) 2MP Lens
- ✓ Day/Night (42 IR LEDs, IR Range 30m)
- ✓ Low Light 0 Lux F1.2
- ✓ Optional B180 Base



TVI1080-659R

- ✓ Fixed-Focal 3.6mm Lens
- ✓ Day/Night (24 IR LEDs, IR Range 10-15m)
- ✓ Low Light 0 Lux F1.2
- ✓ Eyeball (position in any direction)



TVI1080-779VR

- ✓ Vari-Focal 2.8-12mm (adjustable) 2MP Lens
- ✓ Day/Night (36 IR LEDs, IR Range 20-25m)
- ✓ Low Light 0 Lux F1.2
- ✓ Eyeball (position in any direction)
- ✓ Optional B170 Base



TVI1080-049SD

- ✓ Fixed-Focal 3.6mm Lens
- ✓ Low Light 0 Lux F1.2
- ✓ For Internal Use Only



TVI1080-789VR

- ✓ Vari-Focal 2.8-12mm (adjustable) 2MP Lens
- ✓ Day/Night (36 IR LEDs, IR Range 20-25m)
- ✓ Low Light 0 Lux F1.2
- ✓ Vandal Resistant IR Dome
- ✓ Optional Wall Bracket



TVI1080-798VR

- ✓ Vari-Focal 6-22mm (adjustable) 2MP Lens
- ✓ Day/Night (72 IR LEDs, IR Range 50m)
- ✓ Low Light 0 Lux F1.2
- ✓ Configurable DNR, BLC, HLC and AGC
- ✓ Optional B190 Base



TVI1080-589VR

- ✓ SONY 2.1MP CMOS Sensor (1/2.9")
- ✓ Vari-Focal 6-50mm AVF Lens (45-> 4 Degrees)
- ✓ True Day/Night (10 Hi-Power, 50 Normal IR LEDs, 20 Side Pods, IR Range 80m)
- ✓ Configurable Smart IR, DNR, Digital Zoom, BLC
- ✓ On Screen Display (OSD)/Configuration
- ✓ High Light Mask, HSBLCL, Mask Head Lights
- ✓ Block Headlights (HLM) View Number Plates to 25m
- ✓ IP68 Rating



The DDS Difference

- ✓ 2 YEAR Warranty as standard
- ✓ FREE Technical Support

- ✓ FREE Config Help & Training
- ✓ IN STOCK for Next Day Delivery
- ✓ FAST 48 Hour Repair Service

HD-TVI PTZ Features

- ✓ SONY 2MP or 2.4MP CMOS Sensor
- ✓ TVI 1080P Resolution
- ✓ IR-CUT Filter
- ✓ WDR, DNR, BLC
- ✓ RS485, Pelco P/D
- ✓ IP66 Rating

Compatible DVRs

- ▶ Phoenix J & EN Series

P20-21



TVI1080-SD85-10IR

- ✓ 2.4MP SONY CMOS Sensor (1/3")
- ✓ Vari-Focal 5.1-51mm (adjustable) Lens
- ✓ 10X Optical Zoom, Digital Zoom
- ✓ Day/Night (6 Hi Power LEDs, IR Range 50m)
- ✓ Configurable 2-DNR
- ✓ Supports Presets and Tours
- ✓ Includes 12v DC Power Supply Unit
- ✓ Wall Mounting
- ✓ Optional Pole/Corner Mount



TVI1080-SD86-20IR

- ✓ 2MP SONY CMOS Sensor (1/2.8")
- ✓ Vari-Focal 4.7-94mm (adjustable) Lens
- ✓ 20x Optical Zoom, 12x Digital Zoom
- ✓ Day/Night (IR Range 80m)
- ✓ SSNR Noise Reduction
- ✓ Wide Dynamic Range (WDR)
- ✓ Supports Presets, Tours, Auto Scan, Privacy Zones and Alarms
- ✓ Includes 24v Power Supply Unit
- ✓ Wall Mounting
- ✓ Optional Pole/Corner Mount

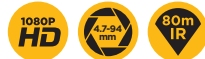

UTP-112PHD

- ✓ Transmits Video and Power Over 1 CAT5 Cable
- ✓ Transmission Distance: TVI 720P up to 300m, TVI 1080P up to 150m, Analogue up to 500m
- ✓ Power Transmission to 50m
- ✓ BNC Male to RJ45 Connector With 13cm Mini Coax Cable for Easy Connection
- ✓ Passive Transceiver
- ✓ Supplied as a Pair



UTP-112HD

- ✓ Transmits Video Over 1 CAT5 Cable
- ✓ Transmission Distance: TVI 720P up to 300m, TVI 1080P up to 200m
- ✓ BNC Male to Screw Terminal With 10cm Mini Coax Cable for Easy Connection
- ✓ Passive Transceiver - No Power Required
- ✓ Supplied as a Pair



TTP-111HDP-LK

- ✓ Transmits Video Over 1 CAT5 Cable
- ✓ Transmission Distance: TVI 720P up to 300m, TVI 1080P up to 200m (Max)
- ✓ Power Transmission to 50m
- ✓ Built in ESD, EFT (impulse noise) and Transient Protection
- ✓ Passive Transceiver
- ✓ Supplied as a Pair



TTP-414HD

- ✓ Transmits up to 4 Video Signals (4 BNC to 1 RJ45)
- ✓ Includes 8 Pin Terminal Block
- ✓ Transmission Distance: TVI 720P up to 300m, TVI 1080P up to 200m (Max)
- ✓ Passive Transceiver - No Power Required
- ✓ One required at Each End of Cable



AD001TVI-U

- ✓ Converts TVI 720P/1080P Signal to HDMI, VGA or as Analogue Composite Video
- ✓ For Use With TVI 720P/1080P Cameras
- ✓ Output Support: HDMI, VGA, Composite Video
- ✓ Up to 3 Outputs, Simultaneously
- ✓ HDMI/VGA Output Support: 720P, 1080P
- ✓ Ideal to Support Local Spot Monitors by Camera
- ✓ Includes 12v Power Adapter

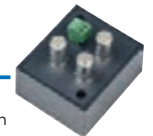

CD102HD-U

- ✓ Distributes HD-TVI Video
- ✓ Supports 720P/1080P Resolution
- ✓ 1 Input, 2 Outputs
- ✓ Built in EQ for Signal Reliability, With Amplifier
- ✓ Includes 12v DC Power Adapter



SP009

- ✓ Provides Protection for HD-TVI and AHD Devices
- ✓ Complies With IEC 61000-4-5
- ✓ BNC Male to BNC Female
- ✓ Built in EFT (impulse noise), Lightning Protection

HD-SDI Features

- ✓ SONY 2.1MP or 2.4MP Sensor
- ✓ HD-SDI 1080P Resolution
- ✓ IR-CUT Filter
- ✓ True Day & Night
- ✓ IP66 Rating

Compatible DVRs

- ▶ Scorpion Range
- ▶ MicroLite HD Series

**P22-23
P24**



LHD-595R

- ✓ 2.1MP SONY Exmor Sensor
- ✓ Fixed-Focal 3.6mm or 6mm Lens
- ✓ Day/Night (2pc IR Array, IR Range 20m)
- ✓ OSD, DWDR, Sense-up, 2D/3D-DNR, Defog



LHD-697BVR

- ✓ 2.1MP SONY Exmor Sensor
- ✓ Vari-Focal 2.8-12mm (adjustable) Lens
- ✓ Day/Night (2pc Hi-Power IR Array, IR Range 35-40m)
- ✓ OSD, DWDR, Sense-up, 2D/3D-DNR, Defog



LHD-659R

- ✓ 2.1MP SONY Exmor Sensor
- ✓ Fixed-Focal 3.6mm Lens
- ✓ Day/Night (2pc IR Array, IR Range 10-15m)
- ✓ OSD, DWDR, Sense-up, 3D-DNR, Defog
- ✓ Eyeball (position in any direction)



KHD-779VR

- ✓ 2.4MP SONY CMOS Sensor
- ✓ Vari-Focal 2.8-12mm (adjustable) Lens
- ✓ Day/Night (36 IR LEDs, IR Range 20-25m)
- ✓ OSD, WDR, BLC, HLC, Sense-up, D-Zoom
- ✓ Eyeball (position in any direction)
- ✓ Optional B170 Base



KHD-769VF

- ✓ 2.1MP Panasonic Sensor
- ✓ Vari-Focal 2.8-12mm (adjustable) Lens
- ✓ Low Light 0.1 Lux Ft.2
- ✓ OSD, WDR, BLC, HLC, Sense-up, D-Zoom, 2D-DNR



KHD-798BVR

- ✓ 2.4MP SONY CMOS Sensor
- ✓ Vari-Focal 6-22mm (adjustable) 2MP Lens
- ✓ Day/Night (72 IR LEDs, IR Range 50m)
- ✓ OSD, WDR, BLC, HLC, Sense-up, DNR, Defog
- ✓ Optional B190 Base



KHD-497BR

- ✓ 2.1MP Panasonic Sensor
- ✓ Fixed-Focal 8mm Lens
- ✓ Day/Night (2pc Hi-Power IR Array, IR Range 40m)
- ✓ OSD, DWDR, Sense-up, 3D-DNR, Defog



KHD-589VR

- ✓ 2.1MP SONY CMOS Sensor (1/2.9")
- ✓ Vari-Focal 6-50mm AVF Lens (45-> 4 degrees)
- ✓ True Day/Night (10 Hi-Power, 50 Normal IR LEDs, 20 Side Pods, IR Range 80m)
- ✓ Configurable Smart IR
- ✓ DNR, Digital Zoom, BLC
- ✓ On Screen Display (OSD)/Configuration
- ✓ High Light Mask, HSBL, Mask Head Lights
- ✓ Block headlights (HLM) View Number Plates to 25m
- ✓ IP68 rating



The DDS Difference

- ✓ 2 YEAR Warranty as standard
- ✓ FREE Config Help & Training
- ✓ FREE Technical Support
- ✓ IN STOCK for Next Day Delivery
- ✓ FAST 48 Hour Repair Service

HD-SDI PTZ Features

- ✓ Exmor 2.1MP Sensor (1/2.8")
- ✓ HD-SDI 1080P Resolution
- ✓ IR-CUT Filter
- ✓ True Day & Night
- ✓ RS-485, Pelco P/D
- ✓ IP66 Rating

Compatible DVRs

- ▶ Scorpion Range
- ▶ MicroLite HD Series

P22-23
P24



KHD86-10IR

- ✓ Auto Iris 5.1-51mm (Auto/Manual Focus) Lens
- ✓ 10X Optical Zoom, WDR
- ✓ Auto Adapting IR (6-48 Degrees)
- ✓ Day/Night (6 Hi Power LEDs, IR Range 50m)
- ✓ Supports Presets, Tours, Auto Scan, Privacy Zones and Alarms
- ✓ Includes Ceiling and Wall Mounts



KHD86-20IR

- ✓ Auto Iris 4.7-94mm (Auto/Manual Focus) Lens
- ✓ 20x Optical Zoom, 12x Digital Zoom, WDR
- ✓ Auto Adapting IR (15-48 Degrees)
- ✓ Day/Night (IR Range 80m)
- ✓ Supports Presets, Tours, Auto Scan, Privacy Zones and Alarms
- ✓ Includes 24v Power Supply Unit
- ✓ Optional Genuine SONY FCB-EH6300
- ✓ Wall Mounting
- ✓ Optional Pole/Corner Mount



HD-04-U

- ✓ Distributes HDMI to multiple HDMI monitors
- ✓ Supports 720P and 1080P
- ✓ 1 HDMI In/4 HDMI Out
- ✓ Reclocks and EQs HDMI Signals



HD-02-U

- ✓ 1 HDMI In/2 HDMI Out



SR02-U

- ✓ Professional RG59 Coaxial Cable Repeater
- ✓ Extends Cable by up to 100 metres
- ✓ Up to 5 Units per Overall Cable Run (maximum of 100m each)
- ✓ Supports Powering Remote Repeaters Over Coax Cable (nearest the DVR)
- ✓ Supports Video and RS-485 Control Data
- ✓ Includes Power Adapter



SDIO3-U

- ✓ High Definition SDI to HDMI Converter With Loop
- ✓ Supports 720p and 1080p Resolution
- ✓ Ideal to Support Local Spot Monitors by Camera
- ✓ Supports Up-Down Scaling
- ✓ Maximum Cable Length 100m
- ✓ Includes Power Adapter



SP007

- ✓ RG59 HD-SDI Surge Protector
- ✓ Provides Protection for HD CCTV Devices
- ✓ Complies With IEC 61000-4-5
- ✓ BNC Male to BNC Female
- ✓ For Use With Professional RG59 Cable



SDIO4DE-U

- ✓ Distributes HD-SDI Video Signals to Multiple HD-SDI Receivers
- ✓ Supports 720p and 1080p Resolution
- ✓ 1 Input and 4 Outputs
- ✓ Built in EQ for Signal Reliability
- ✓ Drives HD Signals to 200m



AHD-DVR-4G



Guardian 4, 8 and 16 Channel DVR

The Guardian range of hybrid H.264 Digital Video Recorders provide a high specification, at truly unbeatable prices. They support new higher resolution AHD-720P cameras and older analogue 960H/D1 variants.

Guardian DVRs support viewing from attached Monitors or TVs and by Apple/Android Smart Phones, Tablets or Windows PCs. With advanced features and a simple to use GUI, Guardian DVRs are ideal for applications from residential use to larger businesses.



AHD-DVR-16G



Guardian DVR Features

- ✓ 4, 8 or 16 Video Channels
- ✓ Hexaplex Operation, Realtime Viewing
- ✓ H.264 Compression (selectable quality)
- ✓ Record Resolution:
 - 4x 720P or 2 x 720P + 2x 960H/D1
 - 8x 720P or 4 x 720P + 4x 960H/ D1
 - 16x 720P or 8 x 720P + 8x 960H/D1
- ✓ Audio: 2 Channel In/1 Channel Out
- ✓ Per Channel Configuration
- ✓ VGA and HDMI Video Outputs
- ✓ Alarms, RS-485 PTZ Control
- ✓ Remote Viewing (Networking), IE Browser (ActiveX)
- ✓ FREE Smart Phone Apps
- ✓ CMS Multi-Site Networking Application
- ✓ Remote Control and Mouse Control
- ✓ Ultra-Quiet Fanless Design (4 and 8 Channel Models)

HDD SIZE	4 CHANNEL AHD-DVR-4G	8 CHANNEL AHD-DVR-8G	16 CHANNEL AHD-DVR-16G
1TB	✓	✓	✓
2TB	✓	✓	✓
3TB	✓	✓	✓
4TB	✓	✓	✓
6TB	✓	✓	✓



WD Purple HDD

- ✓ Built for 24/7 Surveillance
- ✓ AllFrame™ Technology



FREE Smartphone Apps Included

- ✓ Live Viewing
- ✓ Playback
- ✓ Video Snapshot
- ✓ PTZ Controls



DDS DVR Standard Specifications

- ✓ Quick and Easy Setup
- ✓ User Friendly Interface
- ✓ Full Camera Playback
- ✓ Viewable via Mobile Phone
- ✓ Individual Channel Config
- ✓ Remote Connection
- ✓ Monitoring Software
- ✓ 5 Star Rated Service
- ✓ Remote or Mouse Control

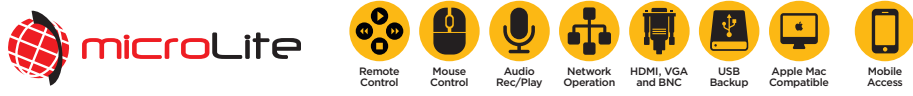

MicroLite 4, 8 and 16 Channel DVR

The MicroLite range of hybrid H.264 Digital Video Recorders provide premium functionality at unbeatable prices, supporting new higher resolution AHD-720P cameras, analogue 960H/ D1 variants and now High Definition IP networked cameras in one single storage facility.

MicroLite DVRs support viewing from attached Monitors or TVs and by Apple/Android Smart Phones, Tablets, Windows PCs and Macs. With advanced features including SMART search and an easy to use GUI, the MicroLite DVR is an ideal choice for professional applications.

WD Purple™

WD Purple HDD

- ✓ Built for 24/7 Surveillance
- ✓ AllFrame™ Technology



FREE Smartphone Apps Included

- ✓ Live Viewing
- ✓ Playback
- ✓ Video Snapshot
- ✓ PTZ Controls



AHD-DVR-16MAH

MicroLite DVR Features

- ✓ 4, 8 or 16 Video Channels
- ✓ Record up to 4 IP Cameras (8 for 16 Channel), Partial Configuration Support
- ✓ Hexaplex Operation, Realtime Viewing
- ✓ Record Resolution:
 - 4x 720P or 2 x 720P + 2x 960H/D1
 - 8x 720P or 4 x 720P + 4x 960H/D1
 - 16x 720P or 8 x 720P + 8x 960H/D1
- ✓ Audio: 4 Channel In/1 Channel Out (8 Channel In on 16 Channel Model)
- ✓ Per Channel Configuration
- ✓ SMART Search
- ✓ VGA, HDMI and BNC Outputs
- ✓ CALL Monitor on 16 Channel Model
- ✓ Alarms, RS-485 PTZ Control
- ✓ Remote Viewing (Networking)
- ✓ FREE Smart Phone Apps
- ✓ CMS Multi-Site Networking Application
- ✓ Apple Mac Support
- ✓ Ultra-Quiet Fanless Design (4 and 8 Channel Models)

HDD SIZE	4 CHANNEL AHD-DVR-4MAH	8 CHANNEL AHD-DVR-8MAH	16 CHANNEL AHD-DVR-16MAH
1TB	✓	✓	✓
2TB	✓	✓	✓
3TB	✓	✓	✓
4TB	✓	✓	✓
6TB	✓	✓	✓

The DDS Difference

- ✓ 2 YEAR Warranty as standard
- ✓ FREE Config Help & Training
- ✓ FREE Technical Support
- ✓ IN STOCK for Next Day Delivery
- ✓ FAST 48 Hour Repair Service



Phoenix 4, 8 and 16 Channel DVR

The Phoenix range of H.264 Digital Video Recorders offer exceptional 'hybrid' functionality at unbeatable prices. Phoenix DVRs support the latest High Definition TVI-1080P, AHD-1080P (EN only) and AHD-720P cameras and the migration from Analogue 960H to HD systems.

Phoenix DVRs support viewing from a locally attached Monitor or TV and by Apple/Android Smart Phones, Tablets, Windows PCs and Macs. With a range of advanced features and simple to use GUI, the Phoenix DVR is now a popular choice when upgrading to High Definition.

WD Purple™

WD Purple HDD

- ✓ Built for 24/7 Surveillance
- ✓ AllFrame™ Technology



FREE Smartphone Apps Included

- ✓ Live Viewing
- ✓ Playback
- ✓ Video Snapshot
- ✓ PTZ Controls



PHD-DVR-16EN

Phoenix DVR Features

- ✓ 4, 8 or 16 Video Channels
- ✓ Pentaplex Operation, Realtime Viewing
- ✓ H.264 Compression (selectable quality)
- ✓ Record Resolution (4J/8EJ):
 - 4x TVI-1080P/AHD-720P
 - 8x TVI-1080P/AHD-720P
- ✓ Record Resolution (EN):
 - 4x TVI-1080P/AHD-1080P/AHD-720P
 - 8x TVI-1080P/AHD-1080P/AHD-720P
 - 16x TVI-1080P/AHD-1080P/AHD-720P
- ✓ Audio: 4 Channel In/1 Channel Out (1 Channel In on 8/16 Channel Models)
- ✓ Per Channel Configuration
- ✓ VGA, HDMI and BNC Outputs
- ✓ Remote Viewing (Networking)
- ✓ FREE Smart Phone Apps
- ✓ CMS Multi-Site Networking Application
- ✓ Apple Mac Support
- ✓ Ultra-Quiet Fanless Design (4 Channel Models)

HDD SIZE	4 CHANNEL		8 CHANNEL		16 CHANNEL
	PHD-DVR-4J	PHD-DVR-4EN	PHD-DVR-8EJ	PHD-DVR-8EN	PHD-DVR-16EN
1TB	✓	✓	✓	✓	✓
2TB	✓	✓	✓	✓	✓
3TB	✓	✓	✓	✓	✓
4TB	✓	✓	✓	✓	✓
6TB	✓	✓	✓	✓	✓
12TB	—	—	—	✓	✓

DDS DVR Standard Specifications

- ✓ Quick and Easy Setup
- ✓ User Friendly Interface
- ✓ Full Camera Playback
- ✓ Viewable via Mobile Phone
- ✓ Individual Channel Config
- ✓ Remote Connection
- ✓ Monitoring Software
- ✓ 5 Star Rated Service
- ✓ Remote or Mouse Control



HD-DVR-4SE2



Scorpion 4, 8 and 16 Channel DVR

The Scorpion range of H.264 Digital Video Recorders offer exceptional 'Full HD' performance with zero latency and are suited to applications requiring the very best in video quality. The Scorpion 'SE' and 'SPH' range comprise up to 16 channels with HDD capacity up to 12TB.

Scorpion DVRs support viewing from attached Monitors or TVs and by Apple/Android Smart Phones, Tablets, Windows PCs and Macs. With a range of advanced features including e-SATA HDD mirroring, the Scorpion DVR is the professional's choice when upgrading to Full HD.



HD-DVR-16SPH



Scorpion DVR Features

- ✓ 4, 8 or 16 Video Channels
- ✓ Hexaplex Operation, Realtime Viewing
- ✓ H.264 Compression (selectable quality)
- ✓ Record Resolution (SE):
 - 4x HD-SDI 1080P/720P
 - 8x HD-SDI 1080P/720P
- ✓ Record Resolution (SPH):
 - 8x HD-SDI 1080P/720P/960H
 - 16x HD-SDI 1080P/720P/960H
- ✓ Audio: 4 Channel In/1 Channel Out (1 In/1 Out on 8/16 Channel Models)
- ✓ Per Channel Configuration
- ✓ VGA, HDMI and BNC (SPH only)
- ✓ Alarms, RS-485 PTZ Control
- ✓ Remote Viewing (Networking)
- ✓ XMS Multi-Site Networking Application
- ✓ Apple Mac Support
- ✓ Ultra-Quiet Fanless Design (SE Range)
- ✓ e-SATA Support



WD Purple HDD

- ✓ Built for 24/7 Surveillance
- ✓ AllFrame™ Technology



FREE Smartphone Apps Included

- ✓ Live Viewing
- ✓ Playback
- ✓ Video Snapshot
- ✓ PTZ Controls



HDD SIZE	4 CHANNEL	8 CHANNEL	16 CHANNEL	
	HD-DVR-4SE2	HD-DVR-8SE	HD-DVR-8SPH	HD-DVR-16SPH
1TB	✓	✓	✓	✓
2TB	✓	✓	✓	✓
3TB	✓	✓	✓	✓
4TB	✓	✓	✓	✓
6TB	✓	✓	✓	✓
12TB	—	—	✓	✓



The DDS Difference

- ✓ 2 YEAR Warranty as standard
- ✓ FREE Config Help & Training
- ✓ FREE Technical Support
- ✓ IN STOCK for Next Day Delivery
- ✓ FAST 48 Hour Repair Service



MicroLite-HD 4 Channel DVR

The MicroLite-HD H.264 Digital Video Recorder offers Full HD quality with zero latency in a slim enclosure; management compatible with the MicroLite AHD DVR range. Suited to applications requiring the very best in video quality, it is an ideal choice when migrating to HD CCTV.

MicroLite-HD DVRs support viewing from attached Monitors or TVs and by Apple/Android Smart Phones, Tablets, Windows PCs and Macs. With advanced features including SMART Search, the MicroLite-HD is the professional's choice when upgrading to Full High Definition.

MicroLite-HD DVR Features

- ✓ 4 Video Channels
- ✓ Hexaplex Operation, Realtime Viewing
- ✓ Record Resolution: 1080P
- ✓ Audio: 2 Channel In/1 Channel Out
- ✓ Per Channel Configuration
- ✓ HDMI, VGA and BNC Outputs
- ✓ Alarms, RS-485 PTZ Control
- ✓ FREE Smart Phone Apps
- ✓ Apple Mac Support
- ✓ Ultra-Quiet Fanless Design

HDD SIZE

		4 CHANNEL HD-DVR-4MH	
1TB	✓	3TB	✓
2TB	✓	4TB	✓



FREE Smartphone Apps Included

- ✓ Live Viewing
- ✓ Playback
- ✓ Video Snapshot
- ✓ PTZ Controls



K-HOMEPLUG-500

- ✓ Interface DVR Ethernet Ports To Your Broadband Router and/or IP Cameras
- ✓ Network Over AC Mains Circuits
- ✓ For Where Running Cables Is Difficult
- ✓ 1m Network Cable Included
- ✓ Indoor Use Only
- ✓ Supplied as a Pair

K-HOMEPLUG-500MP

- ✓ For Multi-Point Applications

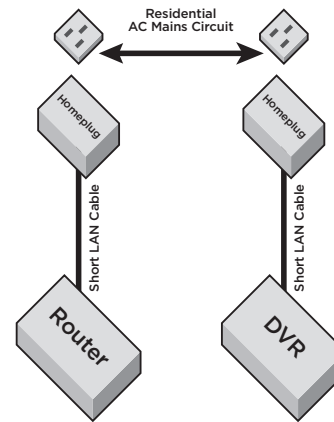

WIFI-WAP202

- ✓ Long Range, Line-Of-Sight Lan Access Bridge
- ✓ Ideal for IP Cameras, DVR and NVR Wire-Free Connections
- ✓ IP65 Waterproof Housing
- ✓ Requires 2 Units per Bridged Connection
- ✓ Multipoint Supported
- ✓ Supplied Pre-Configured, Ready To Use

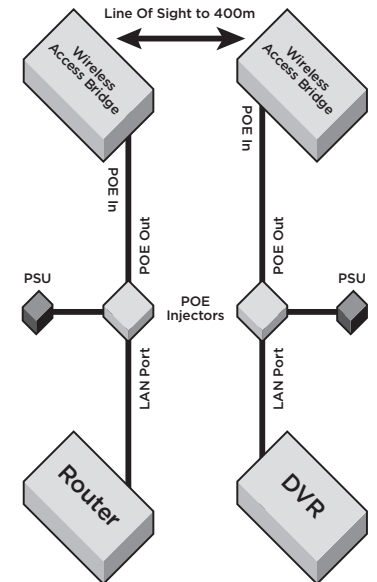

WL-MOUSE



- ✓ Wireless Optical Mouse (2.4Ghz)
- ✓ USB, Compact, Ambidextrous Design
- ✓ Extended Battery Life

IP 1080P Features

- ✓ SONY 2.4MP Sensor (1/2.9")
- ✓ Ambarella Low Power Chip
- ✓ HD 1080P Resolution
- ✓ IR-CUT Filter, WDR
- ✓ ONVIF Compatible
- ✓ Includes POE
- ✓ IP66 Rating

Compatible NVRs

▶ Avenger Range

P28-29



KIP-789VIR

- ✓ Vari-Focal 2.8-12mm (adjustable) 3MP Lens
- ✓ Day/Night (36 IR LEDs, IR Range 25m)
- ✓ Vandal Resistant IR Dome
- ✓ Optional Wall Bracket



KIP-659R

- ✓ Fixed-Focal 3.6mm 3MP Lens
- ✓ Day/Night (24 IR LEDs, IR Range 10-15m)
- ✓ Eyeball (position in any direction)



KIP-779VR

- ✓ Vari-Focal 2.8-12mm (adjustable) 3MP Lens
- ✓ Day/Night (36 IR LEDs, IR Range 30m)
- ✓ Auto ICR
- ✓ Eyeball (position in any direction)
- ✓ Optional B170 Base



SD64-10IR

- ✓ 2.1MP OV Sensor (1/2.7")
- ✓ Auto Iris 5.1-51mm (Auto/Manual Focus) Lens
- ✓ 10X Optical Zoom, Digital Zoom
- ✓ Auto Adapting IR (6-48 Degrees)
- ✓ Day/Night (6 Hi Power LEDs, IR Range 50m), ICR
- ✓ Supports Presets and Tours
- ✓ Includes 12v DC PSU
- ✓ Wall or Ceiling Mounting
- ✓ Optional Pole/Corner Mount



KIP-589VR

- ✓ 2.4MP SONY Sensor (1/2.8")
- ✓ Vari-Focal 6-22mm (adjustable) 3MP Lens
- ✓ Day/Night (72 IR LEDs, IR Range 50m)
- ✓ Auto ICR, POE
- ✓ Optional B190 Base



IP PTZ 1080P Features

- ✓ 2.1MP Sensor (1/2.8")
- ✓ HD 1080P Resolution
- ✓ IR-CUT Filter, WDR
- ✓ True Day & Night
- ✓ RS-485 PTZ Control
- ✓ ONVIF Compatible
- ✓ IP66 Rating

Compatible NVRs

▶ Avenger Range

P28-29



SD64-18IR

- ✓ 2.1MP SONY Sensor (1/2.8")
- ✓ Auto Iris 4.7-84.6mm (Auto/Manual Focus) Lens
- ✓ 18x Optical Zoom, Digital Zoom
- ✓ Auto Adapting IR (15-48 Degrees)
- ✓ Day/Night (8 Hi Power IR LEDs, IR Range 50m), ICR
- ✓ Supports Presets and Tours
- ✓ Includes 24v AC PSU
- ✓ Wall Mounting
- ✓ Optional Pole/Corner Mount



KIP-578VR

- ✓ Vari-Focal 2.8-12mm (adjustable) 3MP Lens
- ✓ Day/Night (42 IR LEDs, IR Range 30m)
- ✓ Auto ICR, WDR
- ✓ Optional B230 Base



LIP-697BVR

- ✓ 2.1MP SONY Exmor Sensor (1/2.9")
- ✓ Vari-Focal 2.8-12mm (adjustable) 2MP Lens
- ✓ Day/Night (2pc IR Array, IR Range 45m)
- ✓ Separate CVBS Video Output (Test)
- ✓ OSD, DWDR, Sense-up, 2D/3D-DNR, Defog



The DDS Difference

- ✓ 2 YEAR Warranty as standard
- ✓ FREE Config Help & Training
- ✓ FREE Technical Support
- ✓ IN STOCK for Next Day Delivery
- ✓ FAST 48 Hour Repair Service



NVR-25AF



NVR-8HAP



Avenger 4, 8, 25, 36 and 64 Channel NVR

The Avenger range of H.264 Network Video Recorders support high performance video storage and networking at resolutions up to 5MP. Avenger NVRs can be used alone or in a distributed storage network.

The Avenger HD NVRs support viewing from attached Monitors or TVs and by Apple/Android Smart Phones, Tablets, Windows PCs and Macs.



WD Purple HDD

- ✓ Built for 24/7 Surveillance
- ✓ AllFrame™ Technology



FREE Smartphone Apps Included

- ✓ Live Viewing
- ✓ Playback
- ✓ Video Snapshot
- ✓ PTZ Controls



Avenger NVR Features

- ✓ 4, 8, 25, 36 or 64 Video Channels @ 960P
- ✓ 8, 16, 25 or 36 Video Channels @ 1080P
- ✓ H.264 Compression (selectable quality)
- ✓ Power Over Ethernet (4 and 8 Channel Models only)
- ✓ Full HD in Live, Recording & Playback
- ✓ Full HD Record Resolution: 5MP and 3MP@30fps (4, 8 and 64 Channel Models only)
- ✓ 1080P, 960P and 720P@30fps (All NVR Models)
- ✓ HDMI/VGA Output in Full HD 1080P
- ✓ Dual Streaming
- ✓ Real Pentaplex Operation (Live, Record, Play, Backup, Network)
- ✓ Smart Apps (iPhone, iPad, Android)
- ✓ Remote Viewing (Networking)
- ✓ VMS Multi-Site Networking Application
- ✓ Apple Mac Support
- ✓ e-SATA Support (64 Channel Model)

HDD SIZE	4 CHANNEL NVR-4HAP	8 CHANNEL NVR-8HAP
1TB	✓	✓
2TB	✓	✓
3TB	✓	✓
4TB	✓	✓

HDD SIZE	25 CHANNEL NVR-25AF	36 CHANNEL NVR-36AF	NVR-36AE	64 CHANNEL NVR-64HE
4TB	✓	✓	✓	✓
6TB	✓	✓	✓	✓
8TB	✓	✓	✓	✓
12TB	✓	✓	✓	✓
16TB	✓	✓	✓	✓
24TB	✓	✓	✓	✓
32TB	—	—	✓	✓
36TB	—	—	✓	✓

DDS NVR Standard Specifications

- ✓ Quick and Easy Setup
- ✓ User Friendly Interface
- ✓ Full Camera Playback
- ✓ Viewable via Mobile Phone
- ✓ Individual Channel Config
- ✓ Remote Connection
- ✓ Monitoring Software
- ✓ 5 Star Rated Service
- ✓ Mouse Control



UTP-SW08

- ✓ POE Ethernet Switch - 8 Port + Uplink
- ✓ Total Output Power 120 Watts
- ✓ Includes 48v DC POE Power Adaptor

UTP-SW08-2L

- ✓ Optional 2 x Uplinks



UTP-SW04

- ✓ POE Ethernet Switch
- ✓ 4 Ports and 2 Uplinks
- ✓ Total Output Power 60 Watts
- ✓ Includes 48v DC POE Power Adaptor



UTP-SW016

- ✓ POE Managed Ethernet Switch
- ✓ 16 Port and 1 Uplink
- ✓ Total Output Power 300 Watts
- ✓ 48v DC POE Power



POE-SPL1

- ✓ Supplies POE Power to Non POE Cameras

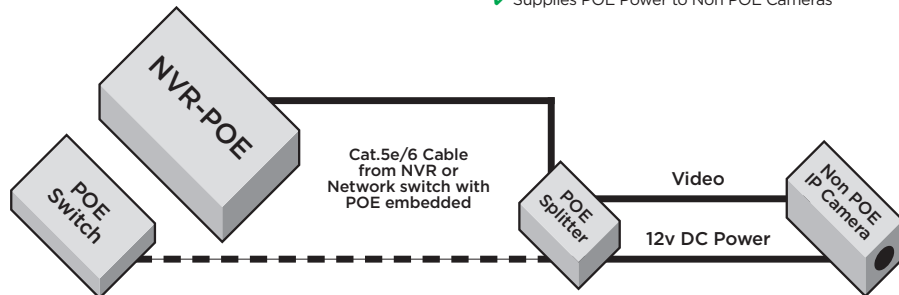

Free Network Configuration

DDS provide an advanced FREE network configuration service enabling you or your customers to quickly view their premises remotely. We recommend that you book your appointment at least a day before, as support slots fill up very quickly.

What We Will Do:

- ▶ Connect to your on-site computer using TeamViewer
- ▶ Configure your DVR/NVR and Broadband router for you
- ▶ Talk you through downloading our smart apps into your customer's mobile phone/Tablet
- ▶ Configure the network access for your customer's PC
- ▶ You do not need to have a static IP for remote access - we can use a standard DDNS service

Pre-Requisites:

- ▶ You have a PC or Laptop onsite
- ▶ You have a Monitor or TV connected to the DVR
- ▶ You have your DVR connected to the router via a LAN cable or using a Homeplug
- ▶ You know the admin username and password for the router (different from the WiFi details)

We do the rest ...

AHK-4R

- ✓ 4 x AHD-659R Cameras
- ✓ 1 x Guardian AHD-DVR-4G DVR
- ✓ 1 x 12v DC 5A PSU and 1:4 Lead



AHK-4VR

- ✓ 4 x AHD-779VR Cameras
- ✓ 1 x Guardian AHD-DVR-4G DVR
- ✓ 1 x 12v DC 5A PSU and 1:4 Lead



AHK-4N

- ✓ 4 x AHD-419R Cameras
- ✓ 1 x Guardian AHD-DVR-4G DVR
- ✓ 1 x 12v DC 5A PSU and 1:4 Lead



AHK-4VN

- ✓ 4 x AHD-579VR Cameras
- ✓ 1 x Guardian AHD-DVR-4G DVR
- ✓ 1 x 12v DC 5A PSU and 1:4 Lead



TVK-4R

- ✓ 4 x TVI-659R Cameras
- ✓ 1 x Phoenix PHD-DVR-4EJ DVR
- ✓ 1 x 12v DC 5A PSU and 1:4 Lead



TVK-4VR

- ✓ 4 x TVI-779VR Cameras
- ✓ 1 x Phoenix PHD-DVR-4EJ DVR
- ✓ 1 x 12v DC 5A PSU and 1:4 Lead



TVK-4N

- ✓ 4 x TVI-419R Cameras
- ✓ 1 x Phoenix PHD-DVR-4EJ DVR
- ✓ 1 x 12v DC 5A PSU and 1:4 Lead



TVK-4VN

- ✓ 4 x TVI-579VR Cameras
- ✓ 1 x Phoenix PHD-DVR-4EJ DVR
- ✓ 1 x 12v DC 5A PSU and 1:4 Lead



HDK-4R

- ✓ 4 x LHD-659R Cameras
- ✓ 1 x Scorpion HD-DVR-4SE2 DVR
- ✓ 1 x 12v DC 5A PSU and 1:4 Lead



HDK-4VR

- ✓ 4 x KHD-779VR Cameras
- ✓ 1 x Scorpion HD-DVR-4SE2 DVR
- ✓ 1 x 12v DC 5A PSU and 1:4 Lead



HDK-4N

- ✓ 4 x LHD-595BR Cameras
- ✓ 1 x Scorpion HD-DVR-4SE2 DVR
- ✓ 1 x 12v DC 5A PSU and 1:4 Lead



HDK-4VN

- ✓ 4 x LHD-697BVR Cameras
- ✓ 1 x Scorpion HD-DVR-4SE2 DVR
- ✓ 1 x 12v DC 5A PSU and 1:4 Lead



IPK-4AE

- ✓ 4 x KIP-595R Cameras
- ✓ 1 x Avenger NVR
- ✓ 1 x 15v DC POE



IPK-4DE
✓ 720P Version



IPK-4R

- ✓ 4 x KIP-659R Cameras
- ✓ 1 x Avenger NVR-4HAP NVR
- ✓ 1 x 48v DC POE



IPK-4VR

- ✓ 4 x KIP-779VR Cameras
- ✓ 1 x Avenger NVR-4HAP NVR
- ✓ 1 x 48v DC POE



IPK-4VN

- ✓ 4 x KIP-578VR Cameras
- ✓ 1 x Avenger NVR-4HAP NVR
- ✓ 1 x 48v DC POE



IPK-4BVN

- ✓ 4 x LIP-697BVR Cameras
- ✓ 1 x Avenger NVR-4HAP NVR
- ✓ 1 x 48v DC POE





12v DC PSUs

- ✓ Regulated 12V DC Power Adapters
- ✓ Supplied With 2.1mm DC Plug

PSU-12VDC1A
✓ Rated at 1A

PSU-12VDC5A
✓ Rated at 5A

PSU-12VDC2A
✓ Rated at 2A

PC-1A
✓ AC to DC Converter
✓ 24VAC to 12V DC
✓ Rated at 1A

PSU-12VDC3A
✓ Rated at 3A



12v DC Central PSUs

- ✓ Regulated (Switch Mode) 12v DC Supplies
- ✓ Supports Multiple CCTV Cameras
- ✓ Each Channel is PTC Fuse Protected (auto reset)
- ✓ Individual LED Status Indicator
- ✓ AC Mains Power With Surge Protection
- ✓ Supplied With Screw Terminal Connections
- ✓ Metal Case With Front Door Key Lock

PSU4-12DC5A
✓ 4 Channel
✓ Rated at 5A

PSU18-12DC10A
✓ 18 Channel
✓ Rated at 10A

PSU9-12DC10A
✓ 9 Channel
✓ Rated at 10A

PSU18-12DC20A
✓ 18 Channel
✓ Rated at 20A

24v AC PSU

- ✓ 24V AC Power Supply
- ✓ Rated at 1A

24v AC Central PSUs

- ✓ AC Power Supplies
- ✓ Supports Multiple CCTV Cameras
- ✓ Each Channel is PTC Fuse Protected (auto reset)
- ✓ Individual LED Status Indicator
- ✓ AC Mains Power With Surge Protection
- ✓ Supplied With Screw Terminal Connections
- ✓ Metal Case With Front Door Key Lock

PSU9-24AC5A
✓ 9 Channel
✓ Rated at 5A

PSU18-24AC10A
✓ 18 Channel
✓ Rated at 10A



PD-009

- ✓ Simple to Supply Multiple CCTV Cameras
- ✓ Individually Surge Protected Outputs
- ✓ Supports up to 1-30VAC/VDC
- ✓ Includes Separate 12v DC 5A Power Adapter



CBL-RG59

- ✓ Professional Grade RG59
- ✓ 100m per Roll
- ✓ Can be Used With Crimp and Twist-On BNC Connectors



CBL-RG59PW-100

- ✓ Professional Grade RG59 plus 2 Core for Power
- ✓ Ideal for Centralised Power Distribution
- ✓ 100m per Roll
- ✓ Can be Used With Crimp and Twist-On BNC Connectors



CAT5e CABLE

- ✓ Unshielded, 4 Pairs Solid Cores
- ✓ Solid Copper and CCA Options
- ✓ Colour: Grey (Internal), Black (External)
- ✓ UTP Double Sheath (External)

CBL-UCAT5E
✓ 305m Copper, Internal

CBL-UCAT5E
✓ 305m CCA, External

CBL-UCAT5E
✓ 100m Copper, External

CBL-UCAT5E
✓ 305m Copper, External

VP-5

- ✓ Pre-Made 5m BNC Video Cable With Power
- ✓ 10m (VP-10), 20m (VP-20), 30m (VP-30) Options

VPS-10

- ✓ 10m Professional Grade
- ✓ 20m (VPS-20) and 30m (VPS-30) Options

DC-Y-1TO4

- ✓ Feed up to 4 Cameras from 1 PSU

- ✓ DC-Y-1TO6
✓ Feed up to 6 Cameras



BNC-LEAD

- ✓ Pre-Made BNC Video Cable
- ✓ 0.5m 1m, 2m, 5m and 10m Options



LAN-CABLE

- ✓ Pre-Made LAN Cable
- ✓ 2m, 3m, 5m, 10m and 20m Options



HD-22LED

- ✓ Full HD (1080P) 22" LED Monitor
- ✓ Resolution of 1920 X 1080P
- ✓ Widescreen (16:9) Aspect Ratio
- ✓ HDMI, VGA, DVI
- ✓ Lifelike Colour (IPS)
- ✓ Wide Viewing Angle
- ✓ Brightness Ratio 50000:1
- ✓ Refresh Rate 5ms



PC-LED-19VGA

- ✓ Adaptable TFT 19" LED Monitor
- ✓ Resolution of 1366 x 768P
- ✓ Widescreen (16:9) Aspect Ratio
- ✓ HDMI, VGA
- ✓ Brightness Ratio 50000:1
- ✓ Refresh Rate 5ms



MON-35TFT

- ✓ 3.5" TFT LCD Monitor
- ✓ Wide Viewing Angle
- ✓ High Resolution
- ✓ Built In Speaker
- ✓ Remote Control Included

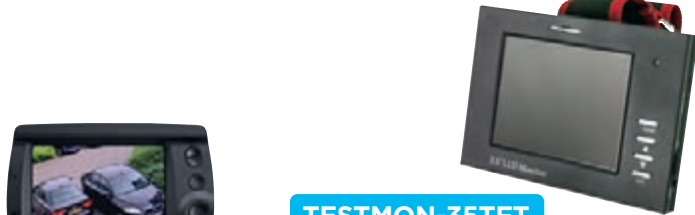

TESTMON-35TFT

- ✓ 3.5" Test LCD Monitor
- ✓ Ideal for Camera Adjustments
- ✓ Supplied With Wrist Strap
- ✓ Supplied With Re-Chargeable Battery and 12v DC, 4W AC Mains Charger



TFT-WM1

- ✓ 17" and 19" Wall Mount
- ✓ VESA Compatible Monitors
- ✓ 2 Direction Movement



TFT-WM3

- ✓ With Extending Arm

HD-04-U

- ✓ Distributes HDMI to Multiple Monitors
- ✓ Supports 720P and 1080P
- ✓ 1 HDMI In/4 HDMI Out
- ✓ Reclocks and EQs HDMI Signal



HD-02-U

- ✓ 1 HDMI In/2 HDMI Out



JUNCTION BOXES

- ✓ Plastic, Waterproof Junction Box (IP56/IP65)
- ✓ Ideal For Camera, PTZ and Video Balun Cable Connections

JB-02

- ✓ Dimensions: 91mm x 91mm x 50(H) mm

JB-03

- ✓ Dimensions: 190mm x 140mm x 70(H) mm

JB-02-BLK

- ✓ Dimensions: 91mm x 91mm x 50(H) mm

JB-04

- ✓ Dimensions: 240mm x 190mm x 90(H) mm

JB-02A

- ✓ Dimensions: 120mm X 80mm X 50(H) mm



CON-DC01

- ✓ DC Plug With Screw Terminals (2.1mm)
- ✓ Makes Termination on Camera End Simple
- ✓ Ideal for Use With RG59 Shotgun and 2 Core Power Cable
- ✓ Pack of 10

CON-DC02

- ✓ DC Socket With Screw Terminals (2.1mm)
- ✓ Makes Termination on Head End Simple
- ✓ Pack of 10



CON1-BNC

- ✓ BNC Crimp Connectors (Pro Quality)
- ✓ Suitable for RG59 Cables
- ✓ Pack of 10

CON2-BNC

- ✓ BNC Connectors Twist-on (Pro Quality)
- ✓ For RG59 Cables
- ✓ Pack of 10

CON9-BJBJ

- ✓ BNC Jack To Jack Adaptor (Pro Quality)
- ✓ For Joining RG59 Video Cables
- ✓ Pack of 5

CON3-BNC

- ✓ BNC Crimp Jack (Pro Quality)
- ✓ For RG59 Cables
- ✓ Pack of 10



CON-RJ45

- ✓ RJ45 Modular Plugs (8pc) - 6U
- ✓ For Use With Cat5/6 Cable
- ✓ Pack of 20

Full Range of Connectors Available at www.ddstrade.co.uk

KEYB-55/85-2/85-3

- ✓ Ideal for the Control of PTZ Cameras
- ✓ Supports a Wide Range of PTZ Camera Protocols
- ✓ Controls up to 32 PTZ Cameras, OSD Menu
- ✓ RS-485, Protocols Include Pelco-D, Pelco-P
- ✓ Full Pan/Tilt/Zoom Control of Camera
- ✓ Suitable for Use With HD-SDI, TVI, AHD and Analogue PTZ Cameras



KEYB-55
✓ 2-Axis Joystick Control



KEYB-85-2
✓ 2-Axis Joystick Control



KEYB-85-3
✓ 3-Axis Joystick Control



SD85-86-C

- ✓ General Corner Mount Bracket
- ✓ Suited to AHD, TVI, HD-SDI and IP PTZ Cameras
- ✓ Connects to Camera Wall Mounting
- ✓ Supplied With Fixing Bolts



SD85-86-P

- ✓ General Pole Mount Bracket
- ✓ Suited to AHD, TVI, HD-SDI and IP PTZ Cameras
- ✓ Connects to Camera Wall Mounting
- ✓ Supplied With Fixing Bolts and Pole Fixings



GX-250

- ✓ 15m or 40m Horizontal and Vertical Curtains
- ✓ IP65 Tough ABS Weather Proof Enclosure
- ✓ Fully Adjustable Detector Head
- ✓ Volt Free Relay Output Selectable, Anti Tamper
- ✓ Compatible With Most Makes of DVRS



DVR-ENCL1

- ✓ Enclosure Keeps Your DVR Safe
- ✓ Fits Most 8/16 Channel DVR's
- ✓ Powder Coated Steel Construction
- ✓ Vented Sides for Improved Airflow
- ✓ Anti-Drill Radial Lock for Added Security
- ✓ Easy Cable Access at the Rear



VS-IR80

- ✓ Provides Extra IR Illumination for IR Cameras
- ✓ 114 Infra-Red (IR) LEDs (8mm Diameter)
- ✓ Infra-Red (IR) Range of 80m
- ✓ Wavelength 850nm, IR Projection 60 Degrees
- ✓ Requires 12V DC 1.5A PSU (or above)

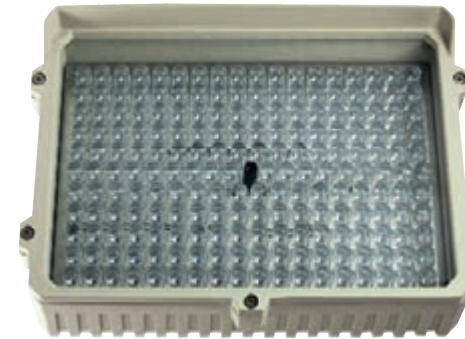

VS-IR130

- ✓ Provides Extra IR Illumination for IR Cameras
- ✓ 198 Infra-Red (IR) LEDs (8mm Diameter)
- ✓ Infra-Red (IR) Range of 130m
- ✓ Wavelength 850nm, IR Projection 60 Degrees
- ✓ Requires 12V DC 3A PSU (or above)



The DDS Difference

- ✓ 2 YEAR Warranty as standard
- ✓ FREE Config Help & Training
- ✓ FREE Technical Support
- ✓ IN STOCK for Next Day Delivery
- ✓ FAST 48 Hour Repair Service

How We Help Our Customers

Register with our friendly trade team and quickly receive your on-line account, giving you instant access to all our products at trade prices where you can order online or by telephone.

Working with our team, we will try to understand your business and furnish you with all relevant product and technology updates, price reductions and weekly campaigns. Our aim is to help you grow your CCTV business.



Personal Account Manager

DDS pride ourselves on providing our customers with the very highest customer experience.

All trade registered customers have their own account manager at DDS providing continuity of service, personal knowledge of product lines and a real in-depth feel for the way in which you like to operate.

From a friendly telephone manner, to the production of quotations that can quickly be cut and pasted, your account manager is here to assist making your product sourcing and supply a seamless extension of your business.

Our team are experienced and knowledgeable, so if you are unsure about any CCTV issue, let DDS come to your help.

FREE Customer Referrals

DDS receive many requests for both the supply and installation of services across the UK. By offering a customer referral service, we distribute these 'leads' across our database of Registered Trade Businesses at no charge.

Helping you, us and the customer to achieve a WIN/WIN solution.

FREE Technical Support

Our experienced in-house technical support team are available to assist you with a wide range of CCTV related topics including:

- ▶ Supply of Pre-Configured DVRs
- ▶ **FREE** Pre-Configuration service for our IP product solutions
- ▶ **FREE** Remote Network configuration service
- ▶ **FREE** Telephone help desk manned by experienced technical engineers, on hand to answer all your product and configuration questions

Tel: 01480 459839
support@ddstrade.co.uk